

# GOLDFISH

## Power Connectors

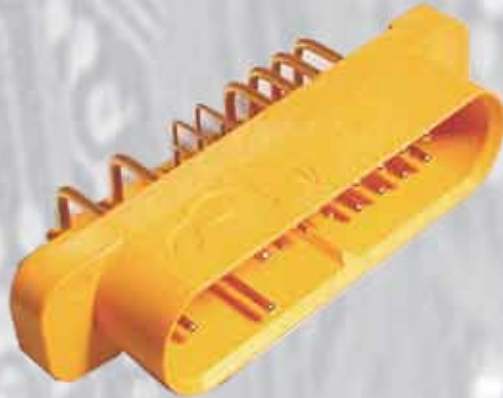
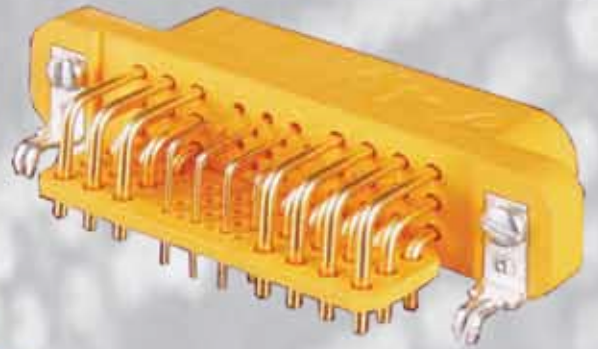

**POSITRONIC**<sup>®</sup>  
GLOBAL *Connector* SOLUTIONS

# Goldfish Power Connectors



## Typical Examples of Goldfish Power Connectors

GFSH02



GFSH624

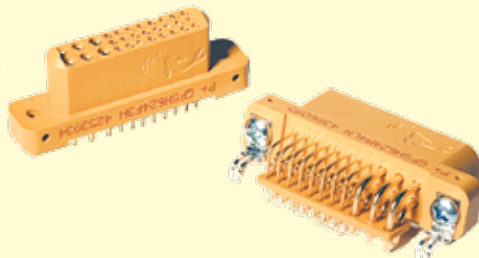

GFSH89



Right Angle (90°) to Straight PCB Mount

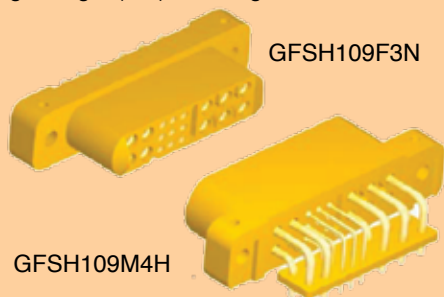

GFSH109F3N

GFSH109M4H

Panel Mount to Panel Mount

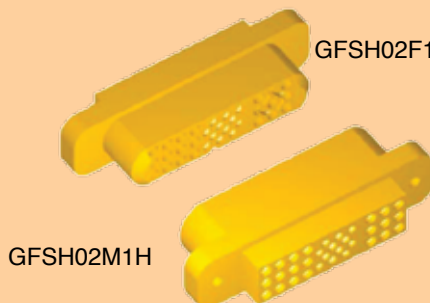

GFSH02F182

GFSH02M1H

## Goldfish Power Connector Features !!!

- **Excellent Power Density**
- **Blind mate - Float mounting**
- **20, 30, 35 and 50 ampere power contacts**
- **Hot Plug Capability**
- **AC, DC and Signal solid machined contacts in one connector**
- **Lower Cost Precision-Formed Female Signal Contacts also available**
- **Safety Agency Recognition**

Unless otherwise specified, dimensional tolerances are:

1. Male contact mating diameters	±0.03 [0.001]
2. Contact termination diameters	±0.08 [0.003]
3. All diameters	±0.13 [0.005]
4. All other dimensions	±0.38 [0.015]
All dimensions are in millimeters [inches]	

Unless otherwise stated, Positronic code and part number are marked on each connector. The contents of the code are subjected to the discretion of Positronic Asia Pte Ltd and it is for internal use only. Marking may be done on either side or both sides of the connector.

Positronic Asia Pte Ltd believes the data contained herein to be reliable. Since the technical information is given free of charge, the user employs such information at his own discretion and risk. Positronic Asia Pte Ltd assumes no responsibility for results obtained or damages incurred from use of such information in whole or in part.

# Goldfish Power Connectors

## Connector versions and technical characteristics



### Connector Versions

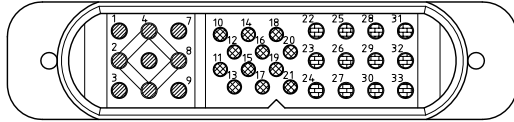

**GFSH02:** Fully populated  
Twenty-one (21) Size 16 power contacts  
Twelve (12) Size 20 signal contacts

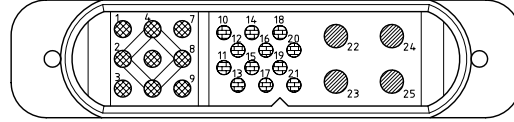

**GFSH435:** Fully populated  
Four (4) size 12 power contacts  
Nine (9) size 16 power contacts  
Twelve (12) size 20 signal contacts

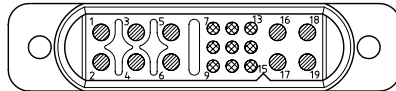

**GFSH109:** Fully populated  
Ten (10) Size 16 power contacts  
Nine (9) Size 22 signal contacts

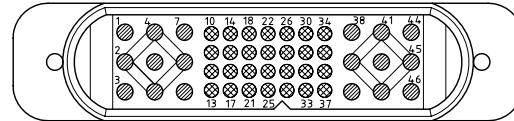

**GFSH928:** Fully populated  
Eighteen (18) Size 16 power contacts  
Twenty-eight (28) Size 22 signal contacts

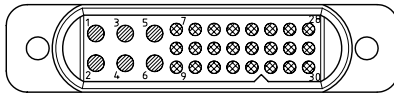

**GFSH624:** Fully populated  
Six (6) size 16 power contacts.  
Twenty four (24) size 22 signal contacts.

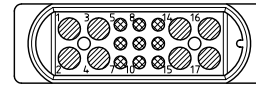

**GFSH89:** Fully populated  
Eight (8) Size 16 power contacts  
Nine (9) Size 22 signal contacts

### Technical Characteristics

#### Materials and Finishes:

Insulator: Glass-filled nylon, UL 94V-0. Color: Orange.  
Contacts: Precision machined copper alloy with gold over nickel plate. Other finishes available upon request. Precision formed copper alloy with selective gold over nickel plate at mating end, and tin over nickel plate at termination end

#### Electrical Characteristics:

Contact Current Ratings (per UL 1977):  
Size 12 Contacts: 35 amperes, continuous (standard material).  
50 amperes, continuous (high conductivity material).  
Size 16 Contacts: 20 amperes, continuous (standard material).  
30 amperes, continuous (high conductivity material).  
Size 20 Contacts: 5 amperes, nominal (standard material).  
Size 22 Contacts: 3 amperes, nominal (standard material).  
1 amperes, nominal (precision-formed).  
Initial Contact Resistance (max.) per IEC 512-2, Test 2b:  
Size 12 Contacts: 0.001 ohms (standard material).  
Size 12 Contacts: 0.0004 ohms (high conductivity material).  
Size 16 Contacts: 0.0016 ohms (standard material).  
0.0007 ohms (high conductivity material).  
Size 20/22 Contacts: 0.005 ohms (standard material).  
Size 22 Contacts: 0.009 ohms (precision-formed).  
Insulator Resistance (per IEC 512-2, Test 3a): 5 G ohms min.

#### Proof Voltage:

Power Contacts: 1500 V r.m.s.  
1300 V r.m.s. (GFSH89 and GFSH624)  
Signal Contacts: 1000 V r.m.s.

#### Working Voltage:

Power Contacts: 500 V r.m.s.  
150 V r.m.s. (GFSH89 and GFSH624)  
Signal Contacts: 333 V r.m.s.

Hot Pluggable (50 couplings per UL 1977, paragraph 15):

Size 12 Contacts: 250 VAC at 25 amperes.  
Size 16 Contacts: Consult factory.

#### Mechanical Characteristics:

Blind Mating System: Molded in guides allow for misalignment up to 2.00 mm [0.079 inch].

Polarization: Provided by insulator.

Removable Contacts: Install contact from rear of insulator; release with extraction tool from front of insulator. Female contacts feature "closed entry" 1,000 cycles design.

Fixed Contacts: Size 12 and 16 female contacts feature "closed entry" 1,000 cycles design (for both straight & right angle (90°) PCB mount). Size 22 machined and precision-formed contacts feature "open entry" 250 cycle design for both straight & right angle (90°) PCB mount.

Contact Retention in insulator (removable and fixed):

Power Contacts: 45 N [10 lbs.] min.  
Signal Contacts: 27 N [6 lbs.] min.

Sequential Mating: Two and three level systems available. Consult factory for customization.

#### Climatic Characteristics:

Working temperature: -55° to +105°C.

#### Recognized:

UL: UL File E49351 is available for all GFSH versions except GFSH928 crimp version.

TÜV: File 006089  
For TÜV, first mate contact is not designed for use as protective earthing terminal. Consult factory for updated information.



## Contact Performance

**Contact Resistance vs Mating Cycles**

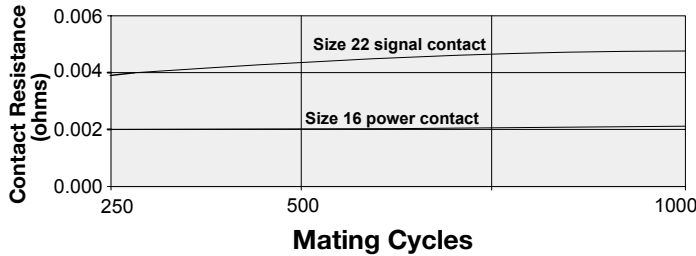

Humidity condition per EIA-364-31B, Method II (condition A) after 250, 500 and 1,000 cycles.  
 Contact resistance tested per IEC 512-2, Test 2b.  
 Connectors tested: GFSH624.

Note: This information is supplied for reference. Contact wear and change in contact resistance may vary from one application to another. Contact technical sales to discuss details.

**Contact Resistance vs Mating Cycles**

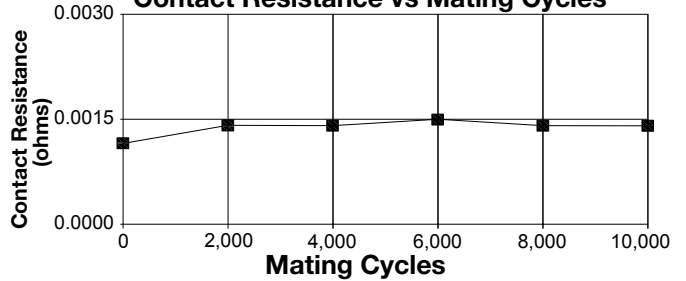

Contact resistance test under 10,000 cycles mechanical operation using GFSH89 with 12 AWG wires and size 16 contacts under load (not utilizing signal contacts).  
 Tested per IEC 512-2, Test 2b. Connectors tested: GFSH89.

## Temperature Rise Curves

**Goldfish Versions 02, 435 and 928**

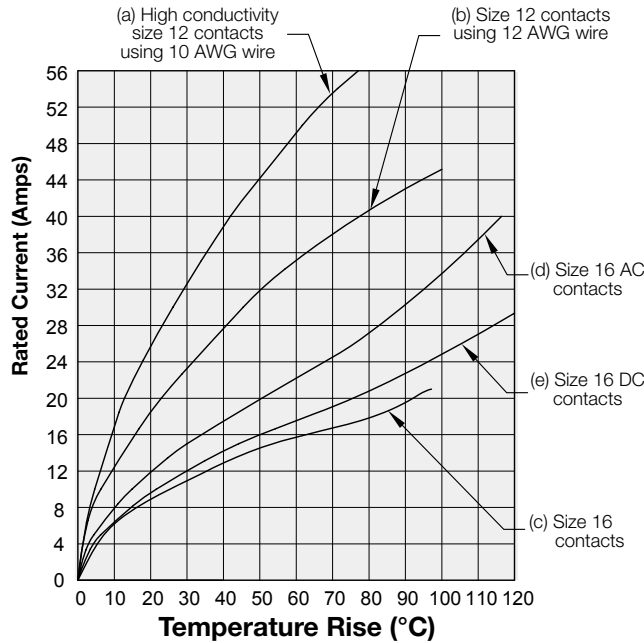

- Connectors tested: GFSH435.**  
 Temperature curve developed using wires of 10 AWG and 12 AWG.  
 For curve (a) and (b).  
 All size 12 contacts under load.
- Connectors tested: GFSH928.**  
 Temperature curve developed using wire of 12 AWG.  
 For curve (c).  
 All size 16 contacts under load.
- Connectors tested: GFSH02.**  
 Temperature curve developed using wire of 12 AWG.  
 For curve (d) and (e).  
 All size 16 contacts under load.

**Goldfish Versions 109, 624 and 89**

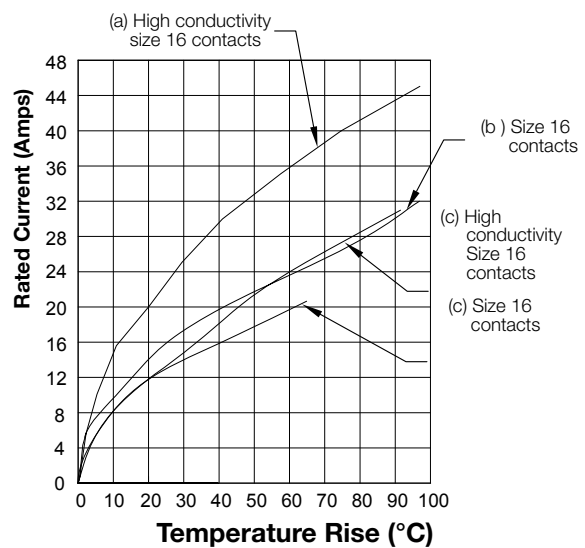

- Connectors tested: GFSH89.**  
 Temperature curve developed using wires of 12 AWG.  
 For curve (a) and (b).  
 All size 16 contacts under load.
- Connectors tested: GFSH624.**  
 Temperature curve developed using wires of 14 AWG.  
 For curve (c).  
 All size 16 contacts under load.
- Connectors tested: GFSH109.**  
 Temperature curve developed using wires of 12 AWG.  
 For curve (d).  
 All size 16 contacts under load.

Tested per IEC Publication 512-3, Test 5a.  
 Note: These information supplied for reference only. Contact wear and change in contact resistance may vary from one application to another. Contact technical sales to discuss details.

# Straight and Right Angle (90°) PCB Mount Connectors Goldfish Versions 02, 435 and 928



## Outline Dimensions

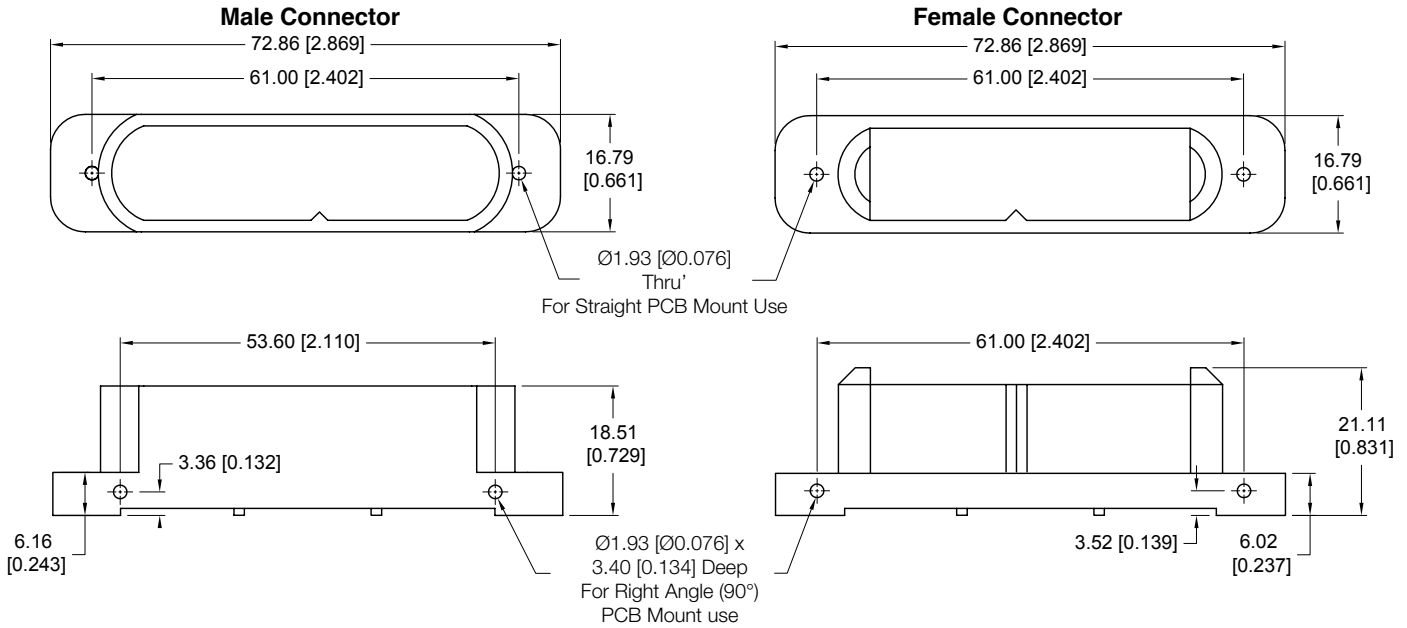

## Contact Termination Dimensions

See Step 4 of Ordering Information

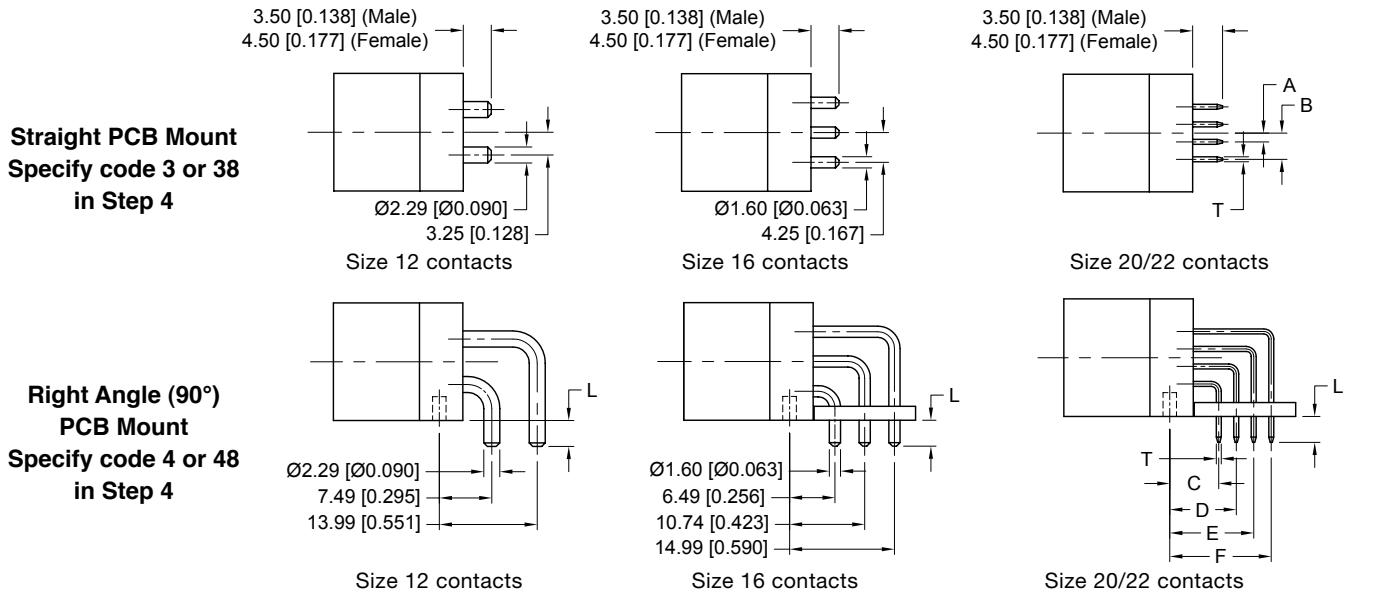

DIM	Goldfish 02/435	Goldfish 928
A	1.25 [0.049]	1.35 [0.053]
B	3.75 [0.148]	4.05 [0.159]
C	6.99 [0.275]	6.49 [0.256]
D	9.49 [0.374]	9.32 [0.367]
E	11.99 [0.472]	12.16 [0.479]
F	14.49 [0.570]	14.99 [0.590]

T = Ø0.71 [Ø0.028]

L = 3.70 [0.146] (Male)

L = 4.50 [0.177] (Female)

Connector shown is male. Unless otherwise specified, above dimensions are identical to female connector.

# Straight and Right Angle (90°) PCB Mount Connectors Baby Goldfish Versions 109 and 624



## Outline Dimensions

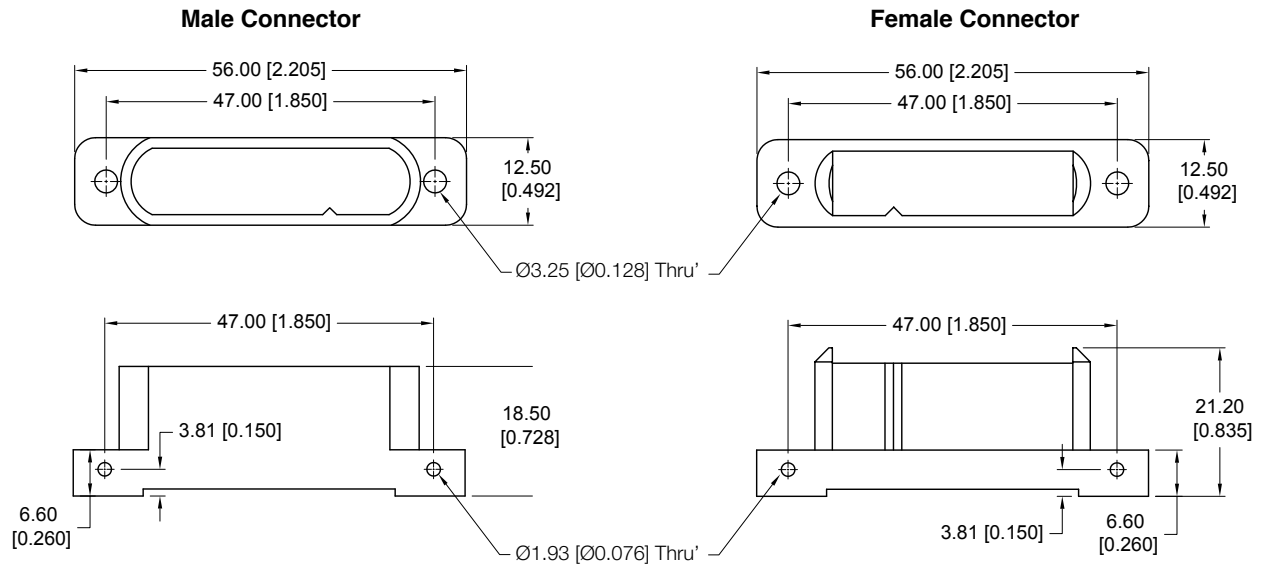

## Contact Termination Dimensions

See Step 4 of Ordering Information

**Straight PCB Mount**  
Specify code 3 or 37  
in Step 4

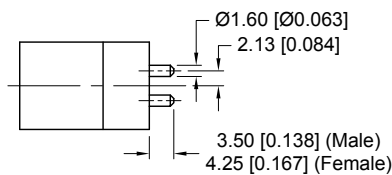

Size 16 contacts

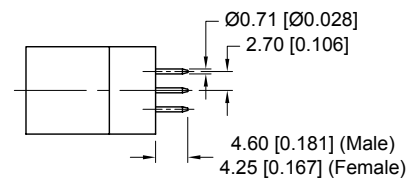

Size 22 contacts

**Right Angle (90°)  
PCB Mount**  
Specify code 4 or 47  
in Step 4

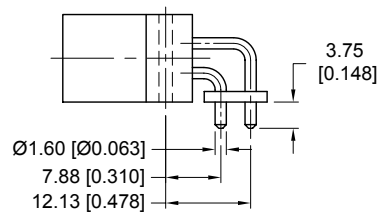

Size 16 contacts

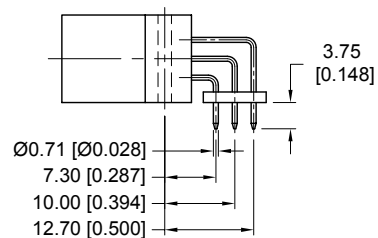

Size 22 contacts

# Panel Mount Connectors (Removable contacts)



## Goldfish Versions 02, 435 and 928

Specify code 1 in Step 4 of Ordering Information

### Outline Dimensions

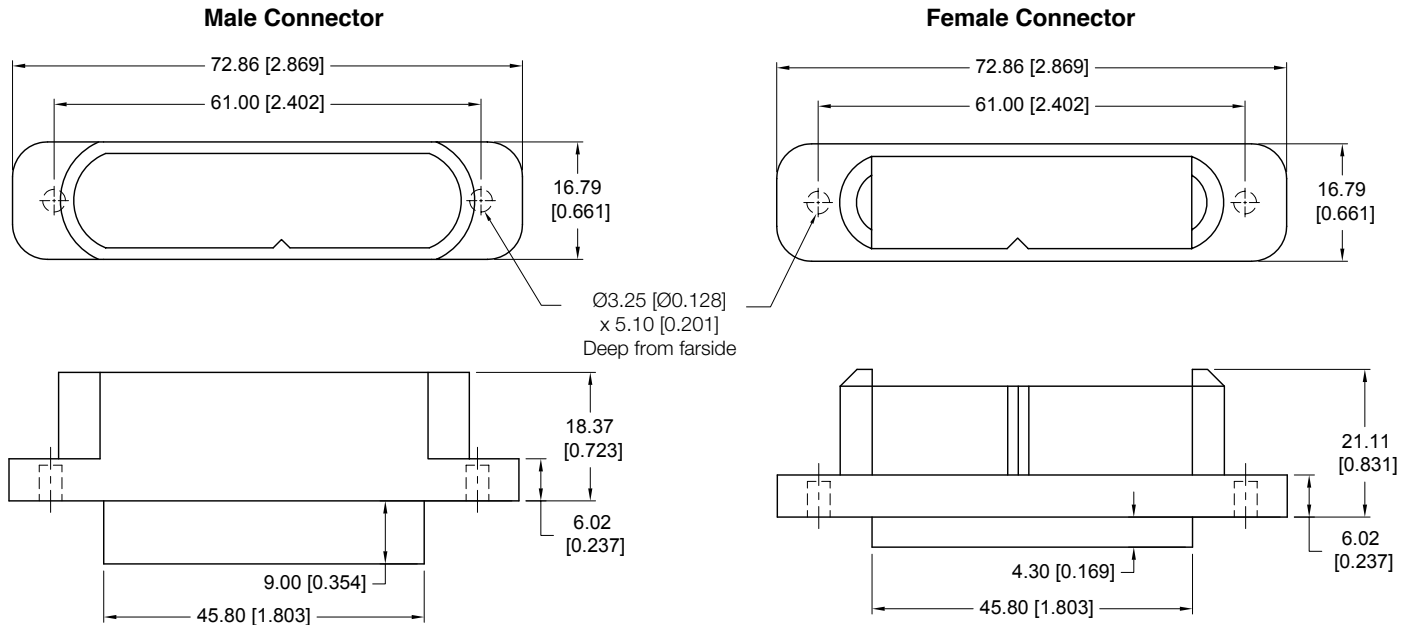

## Baby Goldfish Versions 109 and 624

Specify code 1 in Step 4 of Ordering Information

### Outline Dimensions

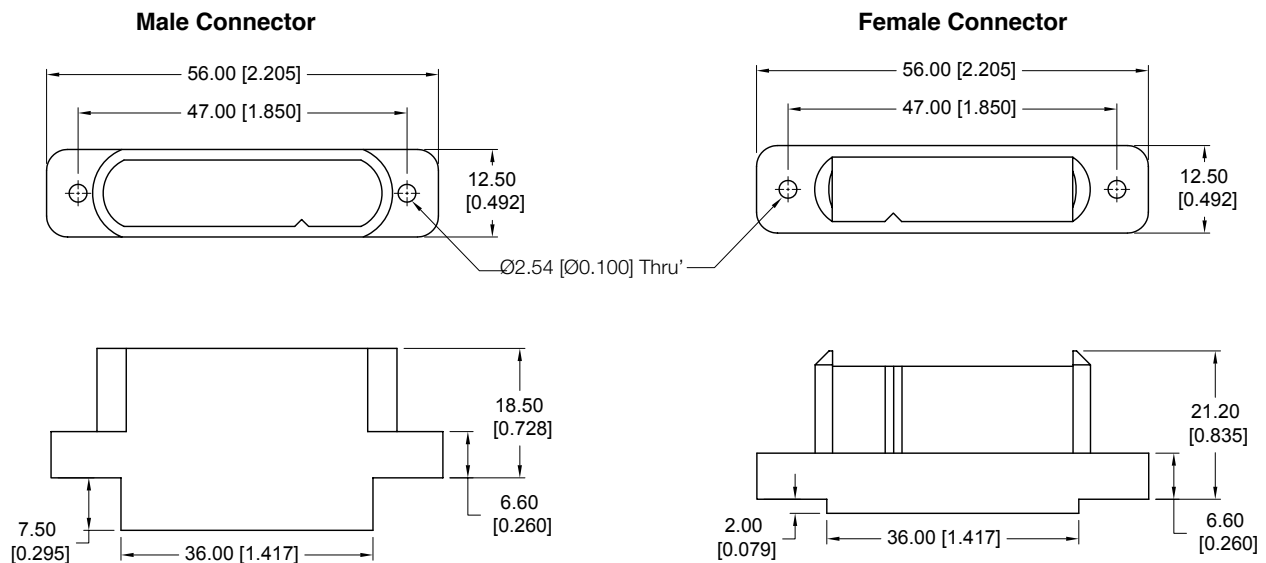

Removable contacts should be allowed to float after installing in connector body for optimum mating.  
Consult factory if alignment insert for male contacts is desired.  
Alignment insert for GFSH89, GFSH109 and GFSH928 are available. Consult factory for other versions.

# Baby Baby Goldfish Version 89



## Straight and Right Angle (90°) PCB Mount Connector Outline Dimensions

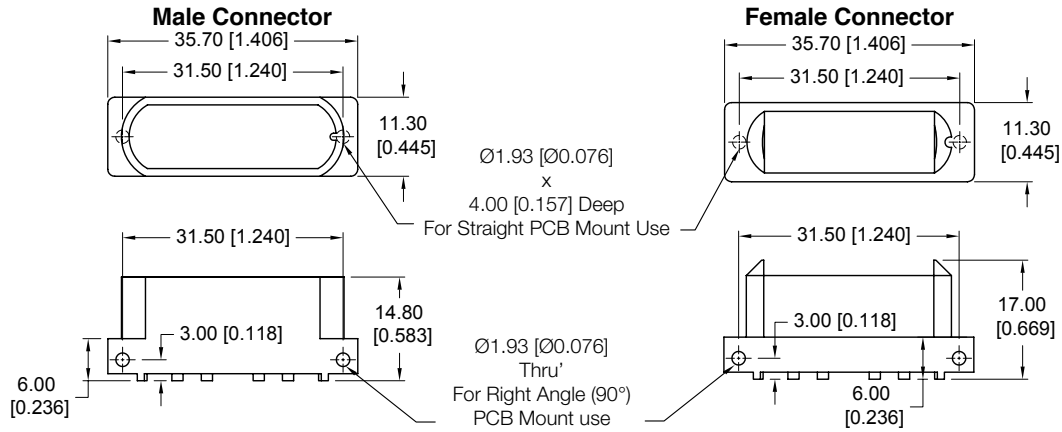

## Contact Termination Dimensions - See Step 4 of Ordering Information

**Straight PCB Mount**  
Specify code 3 or 37  
in Step 4

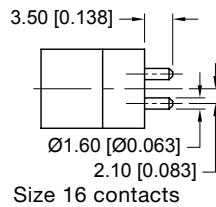

Size 16 contacts

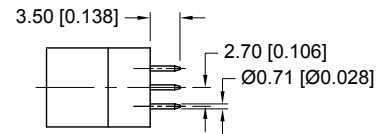

Size 22 contacts

**Right Angle (90°) PCB Mount**  
Specify code 4 or 47  
in Step 4

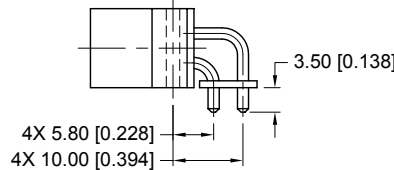

Size 16 contacts

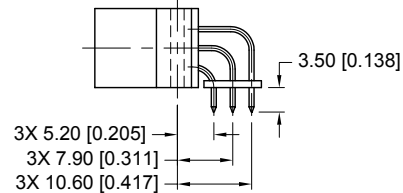

Size 22 contacts

## Panel Mount Connectors

Specify code 1 in Step 4 of Ordering Information

### Outline Dimensions

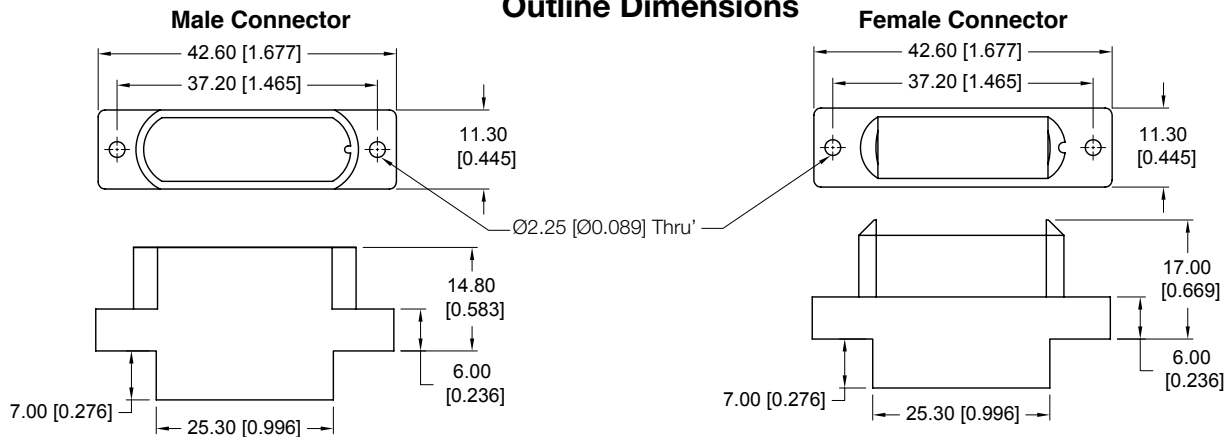

Removable contacts should be allowed to float after installing in connector body for optimum mating.  
Contact factory for additional polarization features for panel mounting.



# Panel Cutout Dimensions (For Panel Mount Connectors)



## Panel Cutout Dimensions (for Float Bushing)

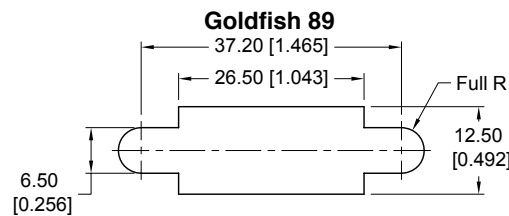
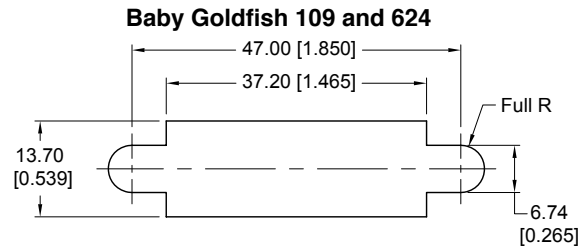
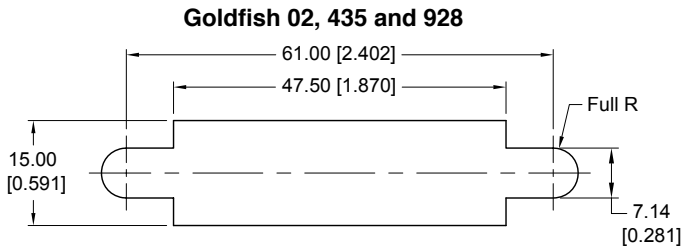

## Panel Cutout Dimensions (for Mounting Screws and Jackscrews)

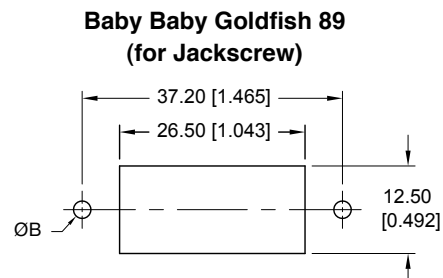
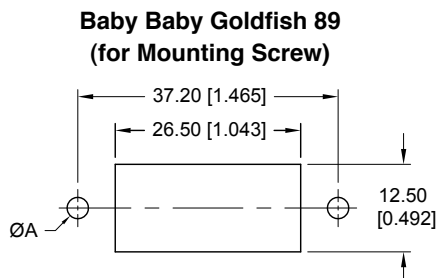
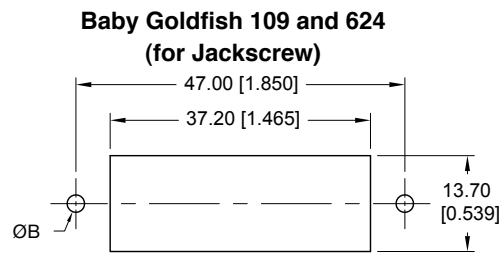
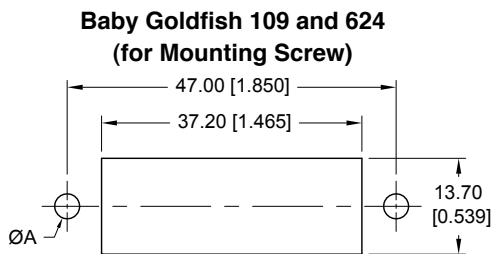
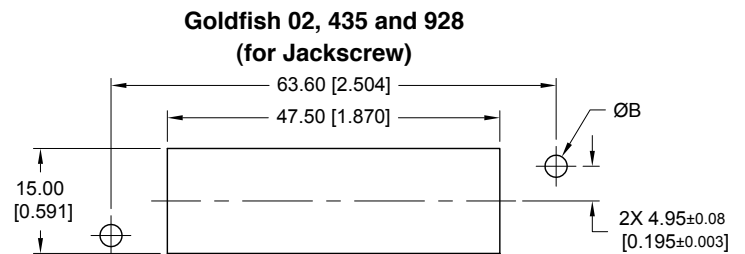
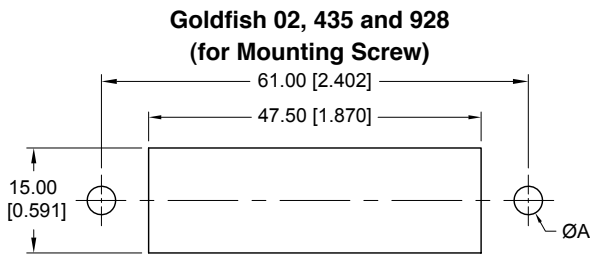

Mounting Screws	ØA ±0.08 [0.003]
02, 435 and 928	4.06 [0.160]
109 and 624	3.56 [0.140]
89	3.05 [0.120]

Jackscrews	ØB ±0.08 [0.003]
02, 435 and 928	3.15 [0.124]
109 and 624	2.49 [0.098]
89	2.49 [0.098]

# Compliant Press-Fit Terminations For Straight PCB Mount Connectors

See Step 4 of Ordering Information



## Contact Termination Dimensions

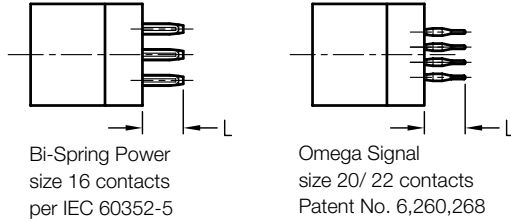

Connector shown is male. Unless otherwise specified, above dimensions are identical to female connector.

## Specify code 93 or 94 in Step 4.



Order Code	"L" Length	PCB Thickness
93	5.72 [0.225]	2.29 to 4.45 [0.090 to 0.175]
94	7.04 [0.277]	4.45 [0.175] min.

Note: Outline dimensions for Press-Fit Connectors are the same as those of Straight PCB Mount Versions.

For Suggested Straight Mount PCB Holes Sizes of Compliant Press-Fit Connectors, please refer to SK6370 or consult factory for more information.

## Press-Fit User Information

### Connectors-to-PCB installation instructions:

1. Choose the proper tooling. Insertion tooling and single contact repair tooling are available from Positronic.
2. Insert the connector into the PCB or backplane and seat connector fully with seating/ support tool.
3. Secure the connector to the PCB or backplane using two self-tapping screws for plastic.

### Need to repair a single contact because of damage in manufacturing, testing, or field use?

1. Choose the proper contact extraction tool.
2. Push the contact out with a firm, steady force. Remember, excessive force is not required.
3. Install a new contact with the proper contact insertion tool. You are done.

### Single Contact Insertion/ Extraction Tools: Ordering Information

Contact Size	Insertion Tool Part No.		Extraction Tool Part No.
Size 16	Male	9513-100-0-0	9513-102-0-0
	Female	9513-101-0-0	
Size 20	Male	9512-100-0-0	9512-102-0-0
	Female	9512-101-0-0	
Size 22	Male	9512-103-0-0	9512-105-0-0
	Female	9512-104-0-0	

### Mounting Screws: Ordering Information

Connector Variant	Screw Part No.
GFSH02/928* 1H	2076-12-6-16
GFSH02/928* 3H	4546- 7 -1-16
GFSH02/928* 4H	4546- 7 -0-16
GFSH02/928*93H	4546- 7 -2-16
GFSH02/928*94H	4546- 7 -3-16
GFSH109/624* 1H	2076-16-1-16
GFSH109/624* 3H	2076-12-6-16
GFSH109/624* 4H	4546- 7 -0-16
GFSH109/624*93H	2076-12-6-16
GFSH109/624*94H	2076-12-0-16
GFSH435* 1 H	2076-12-6-16
GFSH435* 3 H	4546- 7 -1-16
GFSH435* 4 H	4546- 7 -0-16
GFSH435*38H	4546- 7 -1-16
GFSH435*48H	4546- 7 -0-16
GFSH89*1H	4546-14-1-16
GFSH89*3H	4546- 7 -1-16
GFSH89*4H	4546- 7 -0-16
GFSH89*93H	4546- 7 -1-16
GFSH89*94H	4546- 7 -2-16

Material: Steel with Zinc plating

### Connector Installation Tools: Ordering Information

Connector Variant	Seating Tool Part No.	Support Tool Part No.
GFSH02M93/94H	9513-309-2-0	9513-404-1-0
GFSH02F93/94H	9513-309-3-0	
GFSH109M93/94H	9513-309-4-0	9513-404-2-0
GFSH109F93/94H	9513-309-9-0	
GFSH435M93/94H	9513-309-10-0	9513-309-11-0
GFSH435F93/94H	9513-309-5-0	
GFSH624M93/94H	9513-309-12-0	9513-309-13-0
GFSH624F93/94H	9513-309-14-0	
GFSH89M93/94H	9513-309-7-0	9513-309-8-0
GFSH89F93/94H	9513-309-6-0	
GFSH928M93/94H	9513-309-15-0	9513-309-16-0
GFSH928F93/94H	9513-309-17-0	



**Jackscrew Systems for Goldfish Version 89**

**Goldfish Version 89  
(Only for Panel Mount)**

Material: E - Stainless Steel, Passivated.  
T - Stainless Steel, Passivated.

Hex Nut and Lockwashers  
- Stainless Steel, Passivated.  
Knob - Aluminium, Yellow Anodized.

Specify code E in Step 5  
of Ordering Information

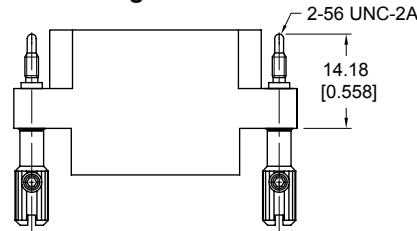

Specify code T in Step 5  
of Ordering Information

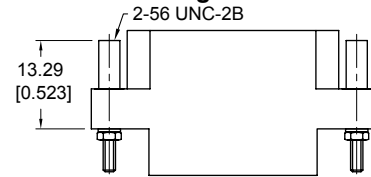

**Jackscrew Systems for Goldfish Version 109 and 624**

**Goldfish Version 109 and 624  
(Panel Mount)**

Material: E - Stainless Steel, Passivated.  
T - Stainless Steel, Passivated.

Hex Nut and Lockwashers  
- Stainless Steel, Passivated.  
Knob - Aluminium, Yellow Anodized.

Specify code E in Step 5  
of Ordering Information

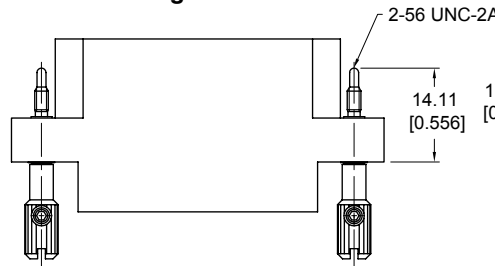

Specify code T in Step 5  
of Ordering Information

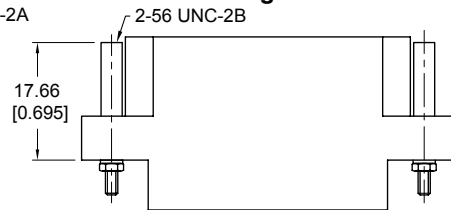

**Goldfish Version 109 and 624  
(Straight or Right Angle (90°))**

Material: T - Stainless Steel, Passivated.

Hex Nut and Lockwashers  
- Stainless Steel, Passivated.  
For PCB version, only T is available.

Specify code T in Step 5 of Ordering Information

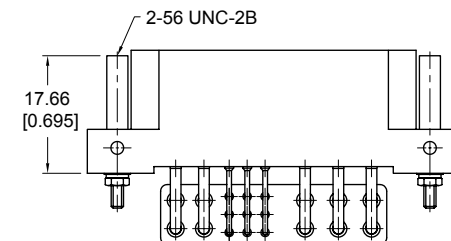
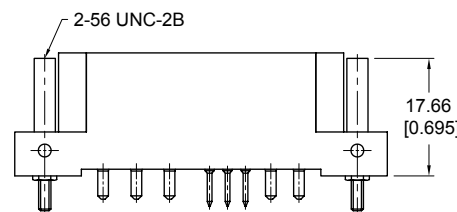

**Note:** For GFSH624, only PCB male fixed jackscrew and Panel female rotating jackscrew is available.

**Jackscrew Systems for Goldfish Version 02, 435 and 928**

**Goldfish Version 02, 435 and 928 (Panel Mount)**

Material:  
E - Steel, zinc plate with dichromate seal or chromate seal.  
Knob - Aluminium, Yellow Anodized.

Material:  
T - Steel, zinc plate with dichromate seal or chromate seal.  
Hex Nut - Brass with dichromate seal or chromate seal  
Lockwashers - Phosphor Bronze with dichromate seal or chromate seal

Consult factory for GFSH02, 435 and 928 PCB version of code T for availability.

Specify code E in Step 5 of Ordering Information

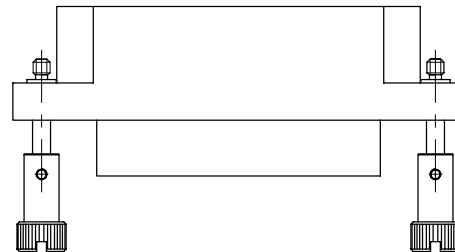

Specify code T in Step 5 of Ordering Information

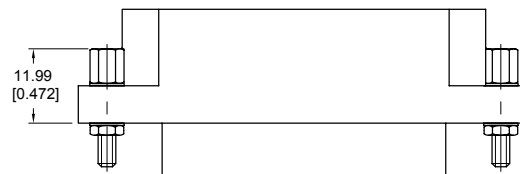

# Modular Cable Clamp Hoods for Goldfish Versions 02, 435 and 928 and Precision-Formed Female Signal Contacts



Specify code W or WE in Step 5 of Ordering Information

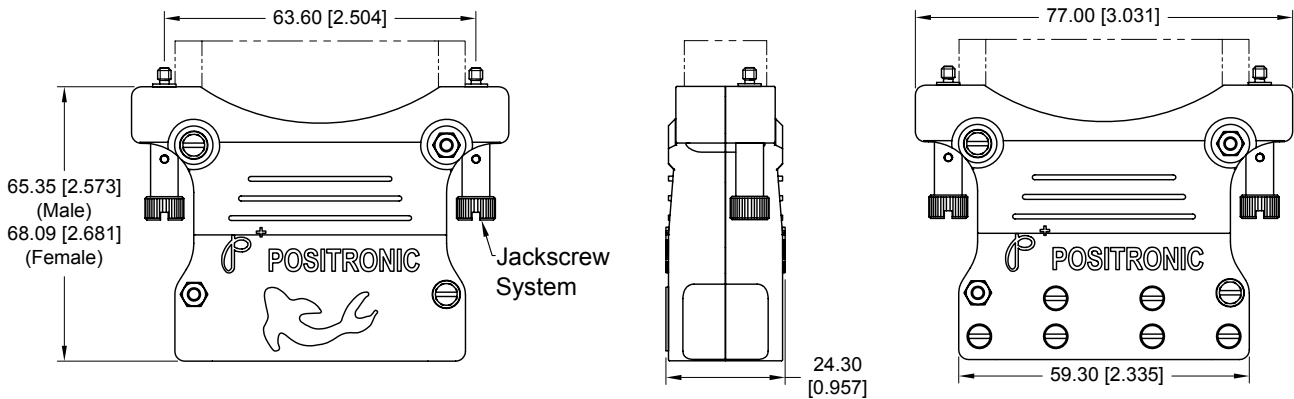

Code W: Hood, Cable Clamps, Hex Nuts and Screws.

Code WE : Hood, Rotating Jackscrews, Cable Clamps, Hex Nuts and Screws.

## Standard Hood and Cable Clamps



GFSH435

**Materials and Finishes:**

**Hood Top and Bottom (Qty: 1x each) :**

Glass-filled nylon, UL 94-0. Black color.

**Cable Clamps (Qty: 3x):**

Steel with Nickel Plate. Screws (Qty: 10x): Brass, zinc plate with chromate seal.

**Hex Nuts (Qty: 4x):**

Brass, zinc plate with dichromate seal or Brass, zinc plate with chromate seal.

**Lockwashers (Qty: 4x):**

Bronze, zinc plate with dichromate seal or Bronze, zinc plate with chromate seal.

## Modular Hood and Cable Clamps

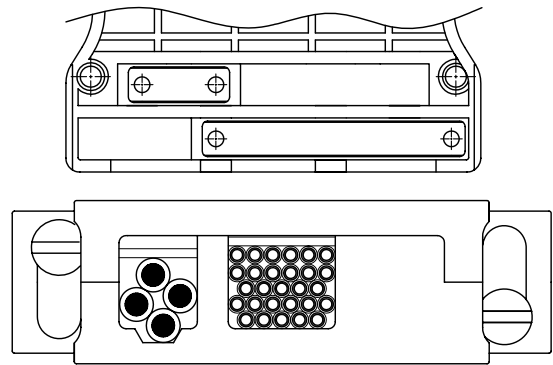

Consult factory for more customized Cable Clamp or Cable openings.

Note: Hood only available for GFSH02, 435 and 928.

Consult factory for GFSH89, 109 and 624 hood availability.

**NEW!**

## Introducing Precision-Formed Female Signal Contacts for the Goldfish Connector Series.



- A Lower Cost and Lower Mating force of Precision-Formed Female Signal Contacts.
- Precision-Formed Female Signal Contacts available for size 22 contacts only.
- Available for Solder, Straight and Right Angle (90°) PCB Mount Versions of Goldfish 109, 624 and 928 FEMALE CONNECTORS ONLY.
- To order, please specify PA688 in step 7 of the GOLDFISH ordering information in page 17.(for example, GFSH624F3H-PA688)

**Note:** For contact termination dimensions and contact hole patterns of straight and right angle (90°) PCB Mount also applied to female connector with precision form signal contacts of MOS PA 688

# Mounting Styles and Contact Hole Patterns for PCB Mount



## Mounting Styles

### Right Angle (90°) Mounting Brackets

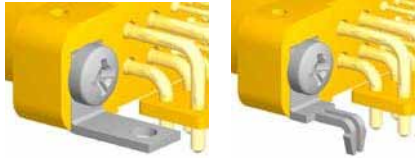

Through Hole (B)

Board Lock (LN)

Specify code B or LN.

Material: Brass with Zinc or Tin plating.

### Push-on Fastener

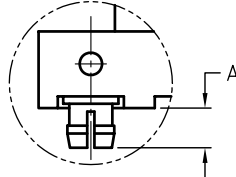

#### Goldfish "A"

02/435	3.17 [0.124]
109/624	3.42 [0.134]
928	3.37 [0.132]
89	3.34 [0.131]

Specify code N.

Material: Copper Alloy with Tin plating.

### Float Mounting Hardware

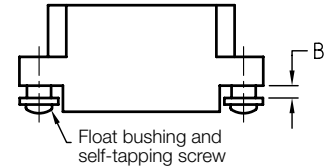

#### Code Goldfish "B"

82	02/435/928	2.00 [0.078]
82	109/624	2.13 [0.083]
82	89	1.52 [0.060]
83	02/435/928	2.70 [0.106]
83	109/624	2.84 [0.111]
83	89	2.79 [0.110]

Specify code 82 or 83.

Material: Steel with Zinc or Tin plating.

Note: For GFSH89 with code 83, consult factory for availability.

## Contact Hole Patterns for Straight PCB Mount

### Goldfish 02 Straight PCB Mount

Code 02 in Step 2

Code 3 in Step 4

Code H or N in Step 5

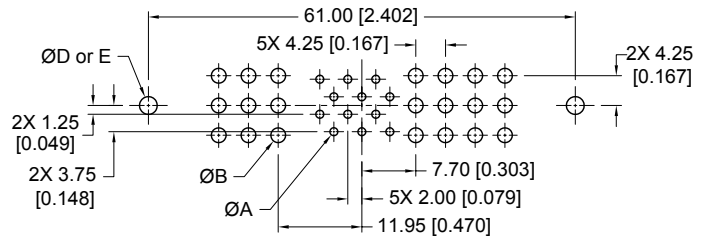

### Goldfish 435 Straight PCB Mount

Code 435 in Step 2

Code 3 or 38 in Step 4

Code H or N in Step 5

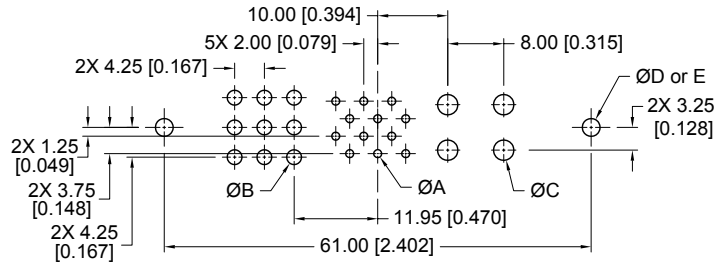

### Goldfish 928 Straight PCB Mount

Code 928 in Step 2

Code 3 in Step 4

Code H or N in Step 5

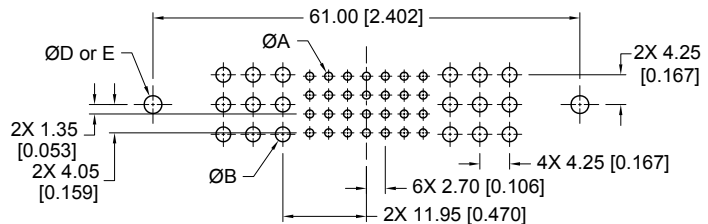

DIM	Suggested size	For use
A	Ø1.14 [0.045]	Size 20 & 22 contact terminals
B	Ø2.11 [0.083]	Size 16 contact terminals
C	Ø2.90 [0.114]	Size 12 contact terminals
D	Ø2.54 [0.100]	Mounting connector with screws
E	Ø3.12±0.08 [0.123±0.003]	Mounting connector using push-on fasteners

(For Suggested Straight Mount PCB Holes Sizes of Compliant Press-Fit Connectors, please refer to SK6370 or consult factory for more information.)  
Hole pattern shown is for male connector. Use mirror image for female connector.

# Goldfish Versions 02, 435 and 928 Contact Hole Patterns for PCB Mount



## Goldfish 02 Right Angle (90°) Mount

Code 02 in Step 2  
Code 4 in Step 4  
Code H, B or LN in Step 5

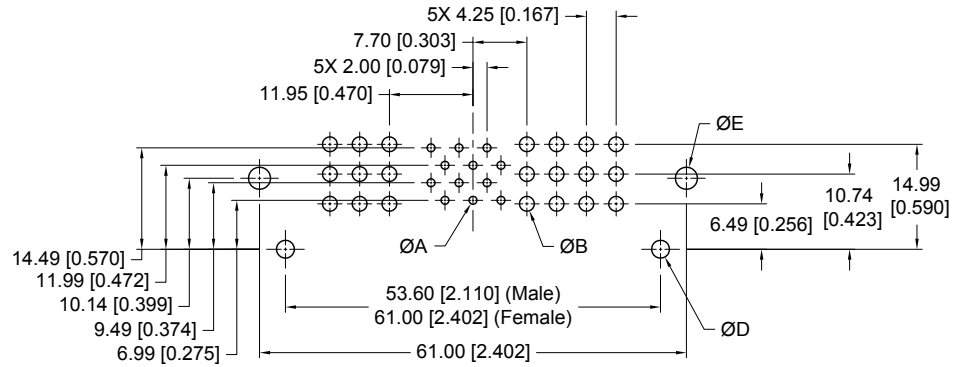

## Goldfish 435 Right Angle (90°) Mount

Code 435 in Step 2  
Code 4 or 48 in Step 4  
Code H, B or LN in Step 5

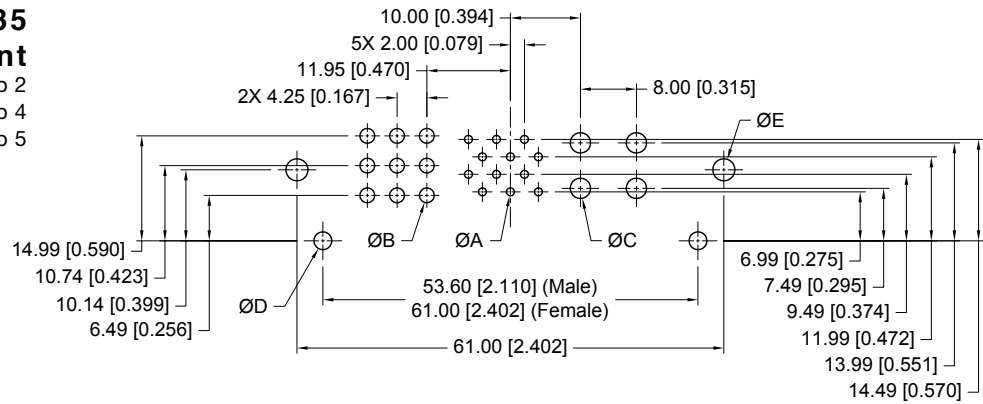

## Goldfish 928 Right Angle (90°) Mount

Code 928 in Step 2  
Code 4 in Step 4  
Code H, B or LN in Step 5

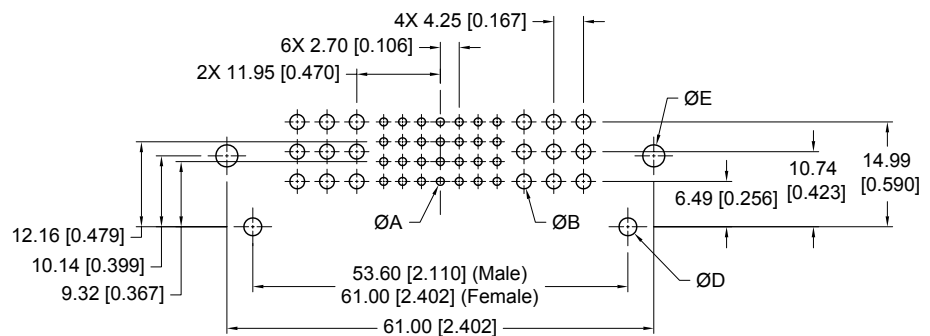

DIM	Suggested size	For use
A	Ø1.14 [0.045]	Size 20 & 22 contact terminals
B	Ø2.11 [0.083]	Size 16 contact terminals
C	Ø2.90 [0.114]	Size 12 contact terminals
D	Ø2.54 [0.100]	Mounting connector with screws
E	Ø3.12 [0.123]	Mounting connector using angle brackets

(For Suggested Straight Mount PCB Holes Sizes of Compliant Press-Fit Connectors, please refer to SK6370 or consult factory for more informations.)

Hole pattern shown is for male connector. Use mirror image for female connector.

# Goldfish Versions 109 and 624 Contact Hole Patterns for PCB Mount



## Goldfish 109 Straight PCB Mount

Code 109 in Step 2  
Code 3 or 37 in Step 4  
Code H or N in Step 5

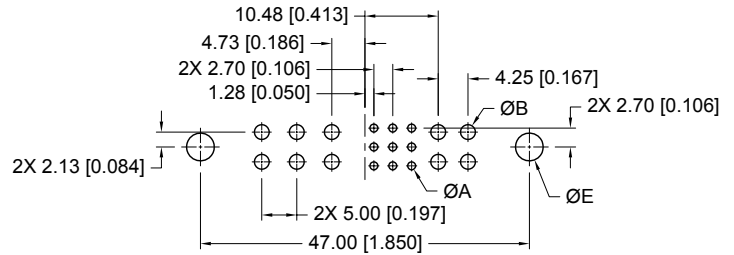

## Goldfish 109 Right Angle (90°) Mount

Code 109 in Step 2  
Code 4 or 47 in Step 4  
Code H, B or LN in Step 5

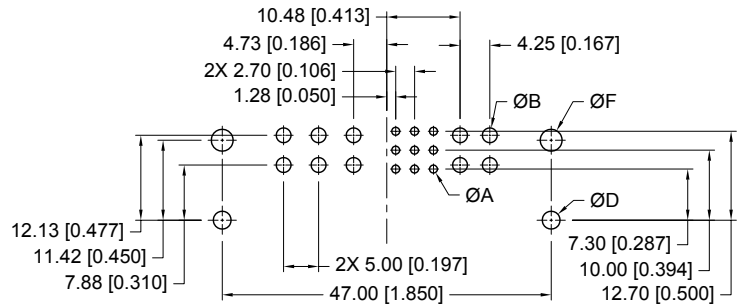

## Goldfish 624 Straight PCB Mount

Code 624 in Step 2  
Code 3 in Step 4  
Code H or N in Step 5

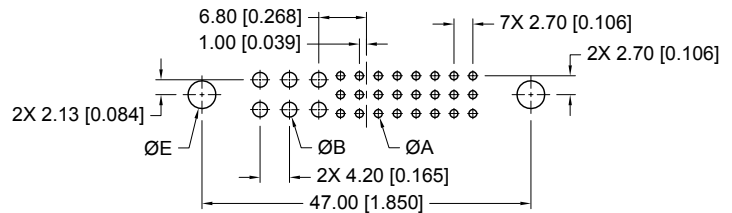

## Goldfish 624 Right Angle (90°) Mount

Code 624 in Step 2  
Code 4 in Step 4  
Code H, B or LN in Step 5

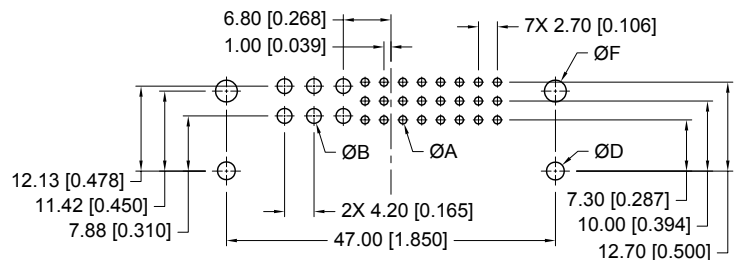

DIM	Suggested size	For use
A	Ø1.14 [0.045]	Size 20 & 22 contact terminals
B	Ø2.11 [0.083]	Size 16 contact terminals
C	Ø2.90 [0.114]	Size 12 contact terminals
D	Ø2.54 [0.100]	Mounting connector with screws
E	Ø3.96±0.08 [0.156±0.003]	Mounting connector using push-on fasteners
	Ø2.49±0.08 [0.098±0.003]	Mounting connector with jackscrew system
F	Ø3.12 [0.123]	Mounting connector using angle brackets

(For Suggested Straight Mount PCB Holes Sizes of Compliant Press-Fit Connectors, please refer to SK6370 or consult factory for more informations.)  
Hole pattern shown is for male connector. Use mirror image for female connector.

# Contact Hole Patterns for PCB Mount (Version 89) and Removable, Solder, Straight PCB Mount Contacts



## Contact Hole Patterns for PCB Mount

### Goldfish 89 Straight PCB Mount

Code 89 in Step 2  
Code 3 or 37 in Step 4  
Code H or N in Step 5

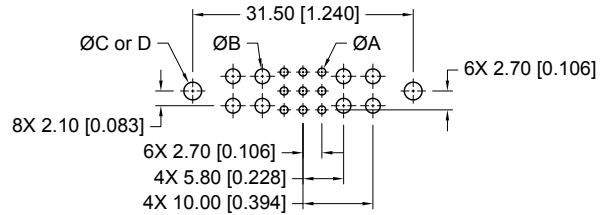

### Goldfish 89 Right Angle (90°) Mount

Code 89 in Step 2  
Code 4 or 47 in Step 4  
Code H or LN in Step 5

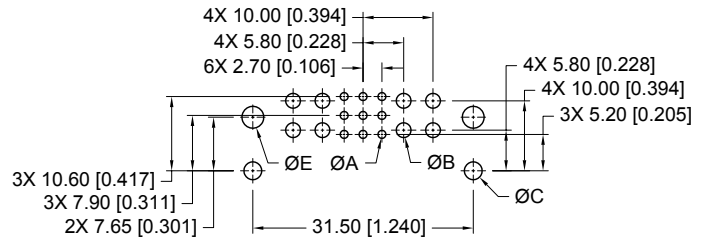

**DIM Suggested size For use**

- A  $\varnothing$ 1.14 [0.045] Size 22 contact terminals
- B  $\varnothing$ 2.11 [0.083] Size 16 contact terminals
- C  $\varnothing$ 2.54 [0.100] Mounting connector with screws
- D  $\varnothing$ 3.12±0.08 [0.123±0.003] Mounting connector with push-on fasteners

**DIM Suggested size For use**

- E  $\varnothing$ 3.12 [0.123] Mounting connector using angle brackets

(For Suggested Straight Mount PCB Holes Sizes of Compliant Press-Fit Connectors, please refer to SK6370 or consult factory for more informations.)

## Removable, Solder, Straight PCB Mount Contacts

### Size 12

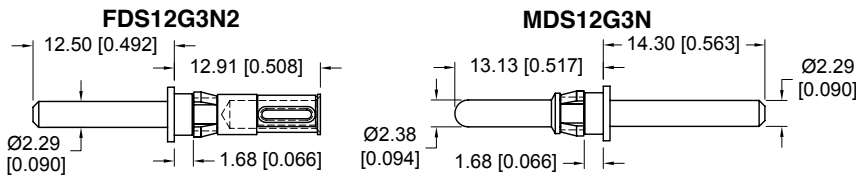

Material and Finishes: Precision machined copper alloy with gold flash over nickel. Other finishes are available.

Now you can easily mix crimp terminations and PCB mount solder terminations within one connector!  
For use in crimp version connectors.

### Size 16

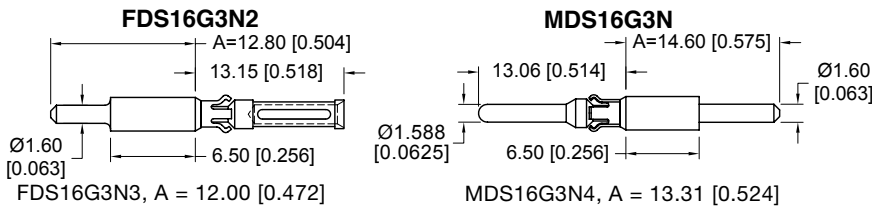

### Contact Ordering Information

Connector Variant	Power Contact	Signal Contact
GFSH02F1H	FDS16G3N2	FDS20G3N2
GFSH02M1H	MDS16G3N	MDS20G3N
GFSH109/624F1H	FDS16G3N3	FDS22G3N2
GFSH109/624M1H	MDS16G3N4	MDS22G3N
GFSH435F1H	FDS16G3N5	FDS20G3N5
	FDS12G3N2	
GFSH435M1H	MDS16G3N	MDS20G3N
	MDS12G3N	
GFSH89F1H	FDS16G3N2	FDS22G3N3
GFSH89M1H	MDS16G3N4	MDS22G3N
GFSH928F1H	FDS16G3N2	FDS22G3N4
GFSH928M1H	MDS16G3N	MDS22G3N3

### Size 20

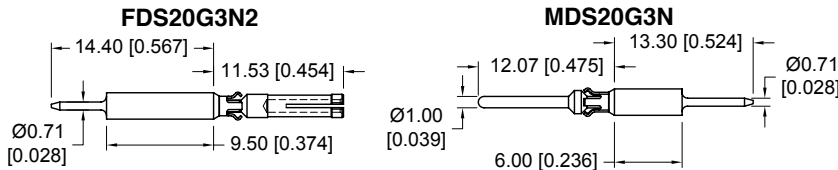

### Size 22

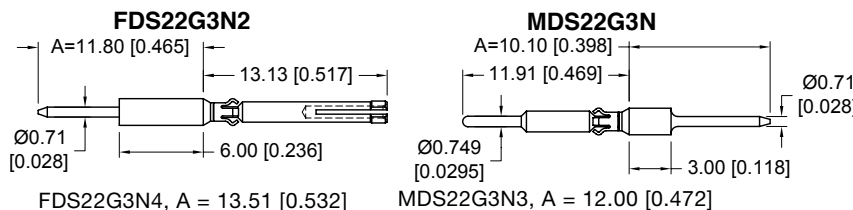

**Reference contact tail length is 4.50 [0.177] beyond insulator.**

Consult factory for other contact sizes.



# Removable Crimp Contacts & Sequential Mating System



## Size 12

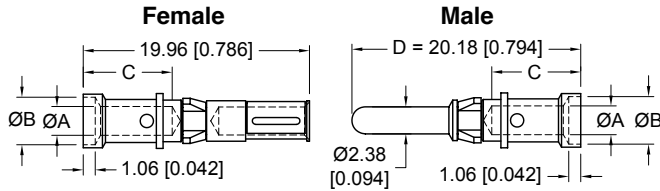

\* First mate contact, D=23.18 [0.913]

Female Contact	Male Contact	** Wire Size AWG [mm <sup>2</sup> ]	ØA	ØB	C
FC610N2	MC610N	10 [6.0]	3.73 [0.147]	N/A	6.45 [0.254]
	MC610N-228.1*				
FC610N2S	MC610NS				
FC612N2	MC612N	12 [4.0]	2.54 [0.100]	4.19 [0.165]	7.90 [0.311]
	MC612N-228.1*				
FC612N2S	MC612NS				

\*\*\*High conductivity material: High conductive copper alloy.

## Size 16

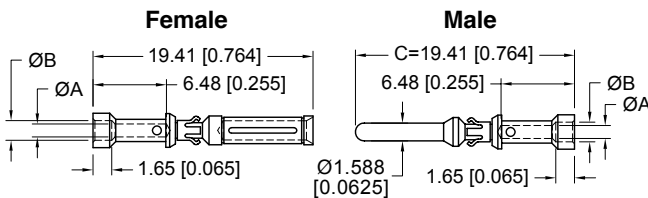

Note: For the first mate contact, it does not apply for GFSH89 version. Consult factory for sequential mating length.

\* First mate contact, C=21.74 [0.856]

Female Contact	Male Contact	** Wire Size AWG [mm <sup>2</sup> ]	ØA	ØB
FC112N2	MC112N	12 [4.0]	2.49 [0.098]	N/A
	MC112N-133.5*			
FC112N2S	MC112NS			
FC114N2	MC114N	14-16 [2.5-1.5]	2.06 [0.081]	2.64 [0.104]
	MC114N-133.5*			
FC116N2	MC116N	16-18 [1.5-1.0]	1.70 [0.067]	2.36 [0.093]
	MC116N-133.5*			
FC120N2	MC120N	20-22-24 [0.5-0.3-0.25]	1.14 [0.045]	1.73 [0.068]
	MC120N-133.5*			

\*\*\*High conductivity material: High conductive copper alloy.

## Size 20

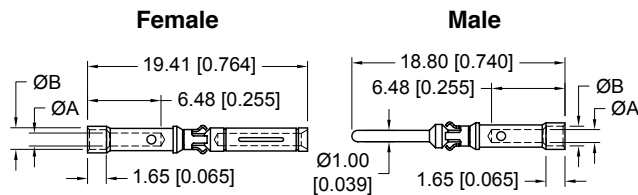

Female Contact	Male Contact	** Wire Size AWG [mm <sup>2</sup> ]	ØA	ØB
FC720N2	MC720N	20-22-24 [0.5-0.3-0.25]	1.14 [0.045]	1.73 [0.068]

## Size 22

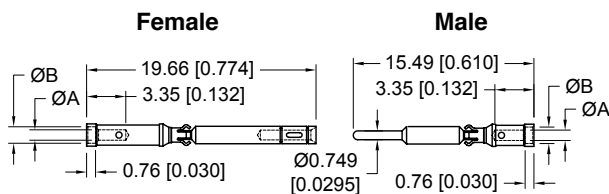

Female Contact	Male Contact	** Wire Size AWG [mm <sup>2</sup> ]	ØA	ØB
FC420N6	MC420N	20 [0.5]	1.14 [0.045]	N/A
FC422N6	MC422N	22 [0.3]	0.89 [0.035]	1.63 [0.064]

Material and Finishes (standard contact): Precision machined copper alloy with gold flash over nickel. Other finishes available.

\*\* Note: Please use correct wire size and it should be smaller than ØA of the contact.

Consult factory for sequential mating and high conductivity material options.

## Sequential Mating Systems

(Available in both PCB and Crimp Version Connectors)

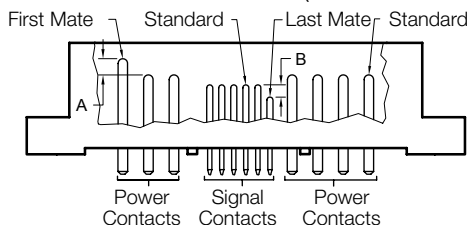

Length of A = 2.69 [0.106]

Length of B = 2.03 [0.080]

Contact factory for ordering information.

Dimensions valid for Goldfish 02 PCB mount versions only.

Contact factory for other versions.

# Connector Ordering Information and Automatic Crimp Machine



Specify complete connector by following step 1 through step 6.  
Include step 7 for customized connectors.

STEP	1	2	3	4	5	6	7
EXAMPLE	GFSH	02	F	4	LN	/AA	XXXXX
<p><b>STEP 1: Basic Series</b> GFSH : Goldfish Series</p> <p><b>STEP 2: Connector Versions</b> 02 : Connector with 21 size 16 power contacts and 12 size 20 signal contacts. 89 : Connector with 8 size 16 power contacts and 9 size 22 signal contacts. 109 : Connector with 10 size 16 power contacts and 9 size 22 signal contacts. 435 : Connector with 9 size 16 power contacts. 4 size 12 power contacts and 12 size 20 signal contacts. 624 : Connector with 6 size 16 power contacts and 24 size 22 signal contacts. 928 : Connector with 18 size 16 power contacts and 28 size 22 signal contacts.</p> <p><b>STEP 3: Connector Gender</b> F : Female M : Male</p> <p><b>STEP 4: Type of Contact</b> 1 : Removable contact, panel/ float mount/ cable version. (contacts ordered separately). 3 : Solder, straight PCB mount. 4 : Solder, right angle (90°) PCB mount. 37 : Solder, straight PCB mount. (high conductivity size 16 power contacts). 38 : Solder, straight PCB mount, GFSH435 only, (high conductivity size 12 power contacts). 47 : Solder, right angle (90°) PCB mount. (high conductivity size 16 power contacts). 48 : Solder, right angle (90°) PCB mount, GFSH435 only. (high conductivity size 12 power contacts). 93 : Press-fit compliant terminations. 94 : Press-fit compliant terminations.</p>							<p><b>STEP 7: Special Options</b> Consult factory for customization of Goldfish Power Connectors. E.g. selective loading, sequential mating, etc.</p> <p><b>STEP 6: Environmental Compliance options</b> /AA : Compliant per EU Directive 2002/95/EC (RoHS) <b>Note:</b> If no environmental options are required, this step will not be used. Examples: GFSH02F4LN</p> <p><b>STEP 5: Mounting Style</b> H : No hardware. For mounting connector with self-tapping screws. (Order screws separately). N : Straight PCB mount push-on fasteners. B : Right angle (90°) PCB mount through hole angle brackets. LN : Right angle (90°) PCB mount board lock angle brackets. 82 : Panel/ float mount for 1.5 mm thick panel. 83 : Panel/ float mount for 2.3 mm thick panel. E : Turnable male jackscrews. (Not available in GFSH624 male panel.) T : Fixed female jackscrews. (Not available in GFSH89 PCB, GFSH624 Female PCB.) TB : Fixed female jackscrews with Right angle (90°) PCB mount through hole angle brackets. TLN : Fixed female jackscrews with Right angle (90°) PCB mount board lock angle brackets. *W : Hood. *WE : Turnable Male Jackscrew with Hood. Notes: *: Not available in GFSH89, 109 and 624.</p>

## Automatic Crimp Machine

### Part No. 9550-0

This fast cycling and reliable automatic crimp machine produces a four double-indent crimp, meeting Military Standard and proprietary specifications on wire sizes 12 AWG (4.0mm<sup>2</sup>) through 30 AWG (0.05mm<sup>2</sup>).

The tool is a bench mount pneumatic unit of compact size and weight. Contacts must be ordered separately and are supplied on a reel in quantities of 2000.

To order, specify part number 9550-0. Foot pedal control valve is supplied as a standard accessory.

### CONTACT CARRIERS

Molded thermoplastic carriers in a continuous belt feed contacts to the crimp station of the automatic feed tool. They also locate the contacts in respect to the tool's indenters. The carriers are color coded white and natural for contact identification for both MS and proprietary applications. Part number for contacts supplied in reels ends with a 'R', example, FC114N2R.

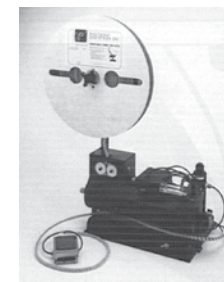
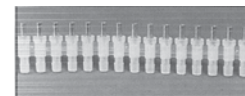

Machine not sold; for rent only.

# Recommended Tools for Crimp Contacts and GG (Giant Goldfish) Series



**Contact Extraction Tool**

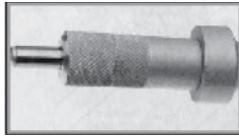

Shown for reference only

**Contact Insertion Tool**

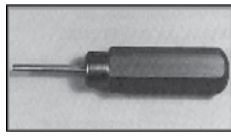

Shown for reference only

**Cycle-Controlled Step Adjustable Hand Tool**



Shown for reference only

Contact Size	Contact Extraction Tool	Contact Insertion Tool	Hand Crimp Tool	Semi-Automatic Crimp Machine
Size 12	2711-0	9099-3	9509-6 (MC/FC610) 9501-0 with 9502-19 positioner (MC/FC612)	-
Size 16	9081-0	9099-0	9501-0 with 9502- 1 positioner 9501-0 with 9502-17 positioner (male first mate contacts)	9550-0
Size 20	9081-2	9099-4	9507-0 with 9502-21 positioner (male contacts) 9507-0 with 9502-22 positioner (female contacts)	9550-1
Size 22	9081-3	9099-1	9507-0 with 9502-12 positioner (male contacts) 9507-0 with 9502-20 positioner (female contacts)	

## GG SERIES CONNECTORS

MODULAR TOOLING ALLOWS DELIVERY OF A MULTITUDE OF VARIANTS!



Contact sales for complete GG series catalog information

### CONTACT VARIANT & DIMENSIONS

Variants shown are not actual size.

**Total of 256 Variants**

4.638 [117.80]

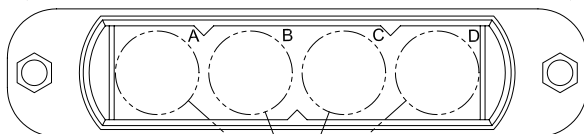

Four (4) modules  
Any combination of modules is possible

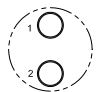

Two (2) size 8 power contact  
(Consult factory for availability)



One (1) size 0 power contact



Four (4) size 12 power contacts



Twelve (12) size 16 power contacts

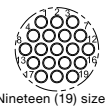

Nineteen (19) size 20 signal contacts

CONTACT SIZE	CONTACT MATERIAL	CONTACT CURRENT RATING	CONTACT RESISTANCE	WORKING VOLTAGE
Size 0	Standard	175 amps	0.00038 ohms	250 V r.m.s
	HC**	200 amps	0.00012 ohms	
Size 12	Standard	35 amps	0.0016 ohms	500 V r.m.s
	HC**	45 amps	0.0005 ohms	
Size 16	Standard	20 amps	0.0024 ohms	500 V r.m.s
	HC**	28 amps	0.0012 ohms	
Size 20	Standard	5 amps	0.0036 ohms	333 V r.m.s

\*\* HC = High Conductivity Contact Material

Insulators:

Contacts:

Electrical characteristics:

Contact resistance:

Voltage proof:

Mechanical operations:

Termination types:

Features:

glass filled nylon, UL 94 V-0, gold color.

precision machined copper alloy. Plated gold flash over nickel. Other finishes available upon request.

contact current ratings to 200 amps per contact in accordance to UL 1977.

as low as 0.00012 ohms, per IEC 512-2, test 2b.

up to 3,000 V r.m.s.

1,000 cycles.

cable and panel mount – crimp, solder or buss bar. Contact Technical Sales for PCB solder type.

Excellent blind mating; sequential mating options

## NORTH AMERICAN SALES OFFICES

United States, Springfield, Missouri  
Factory and Sales Office  
Puerto Rico Sales Office  
Mexico Sales Office  
Canada Sales Office

800 641 4054  
800 641 4054  
800 872 7674  
800 327 8272

info@connectpositronic.com  
info@connectpositronic.com  
info@connectpositronic.com  
info@connectpositronic.com

## EUROPEAN SALES OFFICES

France, Auch Factory and Sales  
Northern France Sales Office  
Southern France Sales Office  
Italy Sales Office  
Germany Sales Office  
United Kingdom Sales Office

33 (0) 5 6263 4491  
33 (0) 1 4588 1388  
33 (0) 6 8648 4023  
39 (0) 2 5411 6106  
49 (0) 23 5163 4739  
44 (0) 7975 682 488

contact@connectpositronic.com  
jchalaux@connectpositronic.com  
plafon@connectpositronic.com  
rmagni@connectpositronic.com  
cbouche@connectpositronic.com  
lbridwell@connectpositronic.com

## Europe & Middle East Technical Agents:

Finland, United Kingdom, Scotland, Israel, Norway, Sweden, Turkey and the Ukraine.

## ASIA/PACIFIC LOCATIONS

### SINGAPORE, Asia/Pacific Headquarters

Factory Sales and Engineering Offices

+65 6842 1419

singapore@connectpositronic.com

### ASIA, Direct Sales Offices

#### China

Factory - Zhuhai  
Shenzhen  
Shanghai  
Xian Sales Office  
Beijing Sales Office

+86 756 3626 466  
+86 158 2907 9779  
+86 158 2907 9779  
+86 029 8839 5306  
+86 10 8203 7718  
+81 3 6310 5830

zhuhai@connectpositronic.com  
shenzhen@connectpositronic.com  
shanghai@connectpositronic.com  
xian@connectpositronic.com  
beijing@connectpositronic.com  
japan@connectpositronic.com

### Japan Sales and Engineering Offices

#### India

Factory Sales and Engineering Offices  
Bangalore Sales Office  
New Delhi Sales Office

+91 20 2469 9910  
+91 94 4907 3251  
+91 80107 11175

india@connectpositronic.com  
bangalore@connectpositronic.com  
delhi@connectpositronic.com

### Korea Sales Office

### Taiwan Sales Office

+82 31 909 8047  
+886 2 2937 8775

korea@connectpositronic.com  
taiwan@connectpositronic.com

## ASIA/PACIFIC, Technical Agents

Technical Agents in Australia, Hong Kong, Malaysia, New Zealand, Philippines, Thailand and Vietnam.

## POSITRONIC INDUSTRIES, INC

423 N Campbell Avenue, P O Box 8247,  
Springfield, MO 65801, USA  
Telephone: 1 417 866 2322  
Fax: 1 417 866 4115  
Email: info@connectpositronic.com

## POSITRONIC INDUSTRIES, SAS

Zone Industrielle Est, 46 Route d'Engachies,  
F32020, Auch Cedex 9, France  
Telephone: 33 (0) 5 62 63 44 91  
Telecopieur: 33 (0) 5 62 63 51 17  
Email: contact@connectpositronic.com

## POSITRONIC ASIA PTE LTD

3014A Ubi Road 1 # 07-01 Singapore 408703  
Telephone: 65 6842 1419 Fax: 65 6842 1421  
Email: singapore@connectpositronic.com

[www.connectpositronic.com](http://www.connectpositronic.com)



**POSITRONIC**<sup>®</sup>  
GLOBAL *Connector* SOLUTIONS

